

Check Valves

10C, 10CO Series, 10,000 psig (690 bar)

15C, 15CO Series, 15,000 psig (1034 bar)

20C, 20CO Series, 20,000 psig (1379 bar)

60C, 60CO Series, 60,000 psig (4137 bar)



Medium & High Pressure Fittings and Tubing

Quick Couplings

Medium & High Pressure Valves

Line Filters

Sour Service Products

Subsea Valves

Tools and Installation Instructions

Technical Information

Contents

10C Series

Pipe O-ring Check Valves	C-52
--------------------------	------

10CO Series

Pipe Ball Check Valves	C-53
------------------------	------

15C Series

O-ring Check Valves	C-54
---------------------	------

Pipe O-ring Check Valves	C-55
--------------------------	------

15CO Series

Ball Check Valves	C-56
-------------------	------

Pipe Ball Check Valves	C-57
------------------------	------

20C Series

O-ring Check Valves	C-58
---------------------	------

20CO Series

Ball Check Valves	C-59
-------------------	------

60C Series

O-ring Check Valves	C-60
---------------------	------

60CO Series

Ball Check Valves	C-61
-------------------	------

Ordering Number Description

	C-62
--	------

Medium & High Pressure
Fittings and Tubing

Quick Couplings

Medium & High Pressure
Valves

Line Filters

Sour Service Products

Subsea Valves

Tools and Installation
Instructions

Technical Information

10C Series

10,000 psig (690 bar)

Pipe O-ring Check Valves

Features

- Fluorocarbon FKM O-ring for operation from 0°F to 400°F (-17.8°C to 204°C), other materials of O-rings available
- Cracking pressure: 14 psig~26 psig (0.966 bar~1.794 bar)
- Provides unidirectional flow and tight shut-off for liquids and gases with high reliability. When differential drops below cracking pressure, valve shuts off (Not for use as relief valve)
- Resilient O-ring seat design for noise-free closing and zero leakage

Standard Materials of Construction

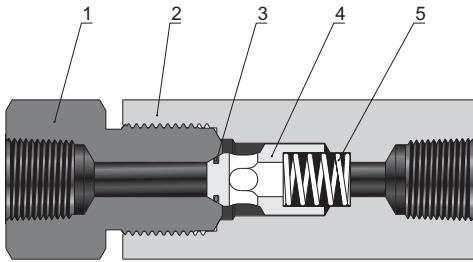

Item	Component	Material Grade/ASTM Specification
1	<i>Cover Gland</i>	<i>316 SS/A479</i>
2	<i>Valve Body</i>	<i>316 SS/A479</i>
3	<i>O-ring</i>	<i>Fluorocarbon FKM</i>
4	<i>Poppet</i>	<i>316 SS/A479</i>
5	<i>Spring</i>	<i>300 Series Stainless Steel</i>
	Lubricant	Molybdenum Disulfide/Fluorinated-based

Wetted components listed in italics.

Ordering Information and Dimensions

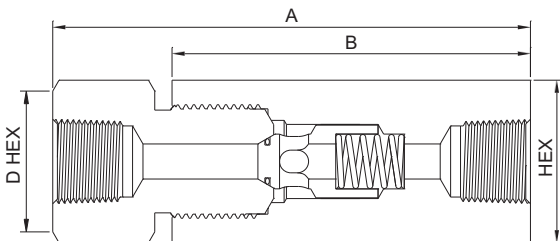

Ordering Number	Connection	Orifice in. (mm)	Cv	Dimensions, in. (mm)				Working Pressure psig (bar)
				A	B	D - HEX	HEX	
10CSS-FNS12	FNS12	0.52 (13.21)	4.70	6.11 (155.3)	4.75 (120.7)	1.5 (38.1)	1.75 (44.5)	10,000 (690)
10CSS-FNS16	FNS16	0.69 (17.53)	7.40	7.33 (186.2)	5.75 (146.1)	1.75 (44.5)	1.88 (47.8)	10,000 (690)

NOTE: For other pipe connections, please refer to 15C Series Pipe O-ring Check Valves for details.

10CO Series

10,000 psig (690 bar)

Pipe Ball Check Valves

Features

- ⦿ Working temperature range: -110°F to 400°F (-79°C to 204°C)
- ⦿ Prevents reverse flow where leak-tight shut-off is not mandatory (Not for use as relief valve)
- ⦿ An integral design of the ball and poppet to assure positive, in-line seating without "chatter".
 Poppet designed essentially for axial flow with minimum pressure drop
- ⦿ Optional wetted materials of cover gland and ball poppet for longer life

Standard Materials of Construction

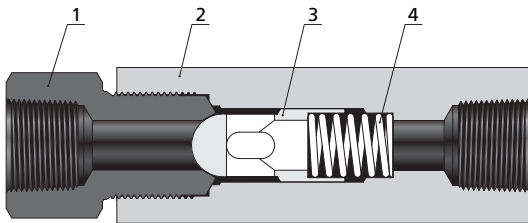

Item	Component	Material Grade/ASTM Specification
1	<i>Cover Gland</i>	<i>316 SS/A479</i>
2	<i>Valve Body</i>	<i>316 SS/A479</i>
3	<i>Ball Poppet</i>	<i>316 SS/A479</i>
4	<i>Spring</i>	<i>300 Series Stainless Steel</i>
	Lubricant	Molybdenum Disulfide/Fluorinated-based

Wetted components listed in italics.

Ordering Information and Dimensions

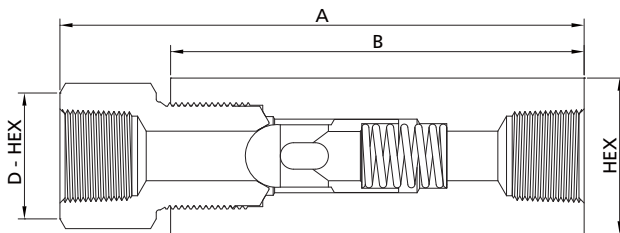

Ordering Number	Connection	Orifice in. (mm)	Cv	Dimensions, in. (mm)				Working Pressure psig (bar)
				A	B	D - HEX	HEX	
10COSS-FNS12	FNS12	0.52 (13.21)	4.70	6.11 (155.3)	4.75 (120.7)	1.5 (38.1)	1.75 (44.5)	10,000 (690)
10COSS-FNS16	FNS16	0.69 (17.53)	7.40	7.33 (186.2)	5.75 (146.1)	1.75 (44.5)	1.88 (47.8)	10,000 (690)

NOTE: For other pipe connections, please refer to 15CO Series Pipe Ball Check Valves for details.

Medium & High Pressure Fittings and Tubing

Quick Couplings

Medium & High Pressure Valves

Line Filters

Sour Service Products

Subsea Valves

Tools and Installation Instructions

Technical Information

15C Series

15,000 psig (1034 bar)

O-ring Check Valves

Features

- Fluorocarbon FKM O-ring for operation from 0°F to 400°F (-17.8°C to 204°C), other materials of O-rings available
- Tubing sizes available in 1/4", 3/8" and 1/2"
- Cracking pressure: 14 psig~26 psig (0.966 bar~1.794 bar)
- Provides unidirectional flow and tight shut-off for liquids and gases with high reliability. When differential drops below cracking pressure, valve shuts off (Not for use as relief valve)
- Resilient O-ring seat design for noise-free closing and zero leakage

Standard Materials of Construction

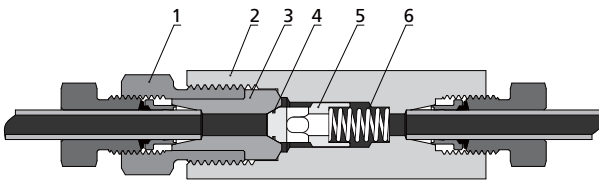

Item	Component	Material Grade/ASTM Specification
1	Cover Gland	316 SS/A479
2	Valve Body	316 SS/A479
3	Cover	316SS/A479
4	O-ring	Fluorocarbon FKM
5	Poppet	316 SS/A479
6	Spring	300 Series Stainless Steel
Lubricant		Molybdenum Disulfide/Fluorinated-based

Wetted components listed in italics.

Ordering Information and Dimensions

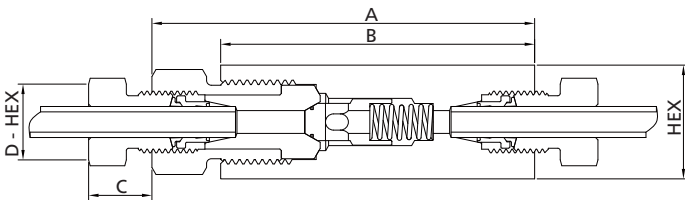

Ordering Number	Connection	Orifice in. (mm)	Cv	Dimensions, in. (mm)					Working Pressure psig (bar)
				A	B	C	D - HEX	HEX	
15CSS-DHL4	DHL4	0.188 (4.78)	0.63	3.35 (85)	2.72 (69.2)	0.52 (13.3)	0.63 (16.0)	0.81 (20.6)	15,000 (1034)
15CSS-DHL6	DHL6	0.250 (6.35)	1.70	3.72 (94.6)	3.13 (79.6)	0.53 (13.5)	0.75 (19.1)	1.00 (25.4)	15,000 (1034)
15CSS-DHL8	DHL8	0.375 (9.53)	3.40	4.41 (112.0)	3.68 (93.5)	0.60 (15.3)	0.93 (23.6)	1.38 (35.1)	15,000 (1034)

Pipe O-ring Check Valves

Features

- Fluorocarbon FKM O-ring for operation from 0°F to 400°F (-17.8°C to 204°C), other materials of O-rings available
- Cracking pressure: 14 psig~26 psig (0.966 bar~1.794 bar)
- Provides unidirectional flow and tight shut-off for liquids and gases with high reliability. When differential drops below cracking pressure, valve shuts off (Not for use as relief valve)
- Resilient O-ring seat design for noise-free closing and zero leakage

Standard Materials of Construction

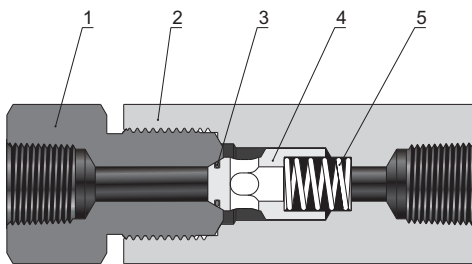

Item	Component	Material Grade/ASTM Specification
1	<i>Cover Gland</i>	<i>316 SS/A479</i>
2	<i>Valve Body</i>	<i>316 SS/A479</i>
3	<i>O-ring</i>	<i>Fluorocarbon FKM</i>
4	<i>Poppet</i>	<i>316 SS/A479</i>
5	<i>Spring</i>	<i>300 Series Stainless Steel</i>
	Lubricant	Molybdenum Disulfide/Fluorinated-based

Wetted components listed in italics.

Ordering Information and Dimensions

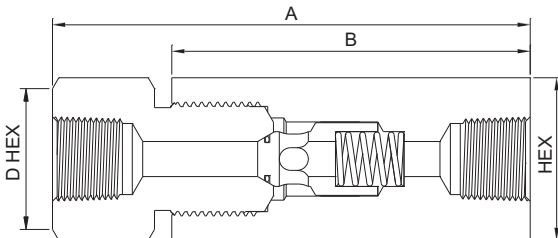

Ordering Number	Connection	Orifice in. (mm)	Cv	Dimensions, in. (mm)				Working Pressure psig (bar)
				A	B	D - HEX	HEX	
15CSS-FNS4	FNS4	0.12 (3.05)	0.28	3.30 (83.8)	2.38 (60.3)	0.94 (23.8)	0.94 (23.8)	15,000 (1034)
15CSS-FNS6	FNS6	0.22 (5.59)	0.84	3.95 (100.3)	2.88 (73.2)	1.13 (28.6)	1.13 (28.6)	15,000 (1034)
15CSS-FNS8	FNS8	0.36 (9.12)	2.30	5.07 (128.9)	3.88 (98.6)	1.38 (34.9)	1.38 (34.9)	15,000 (1034)

Medium & High Pressure Fittings and Tubing
 Quick Couplings
 Medium & High Pressure Valves
 Line Filters
 Sour Service Products
 Subsea Valves
 Tools and Installation Instructions
 Technical Information

15CO Series

15,000 psig (1034 bar)

Ball Check Valves

Features

- ⦿ Working temperature range: -110°F to 800°F (-79°C to 427°C)
- ⦿ Tubing sizes available in 1/4", 3/8" and 1/2"
- ⦿ Prevents reverse flow where leak-tight shut-off is not mandatory (Not for use as relief valve)
- ⦿ An integral design of the ball and poppet to assure positive, in-line seating without "chatter".
 Poppet designed essentially for axial flow with minimum pressure drop
- ⦿ Optional wetted materials of cover gland and ball poppet for longer life

Standard Materials of Construction

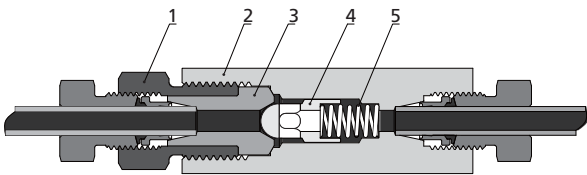

Item	Component	Material Grade/ASTM Specification
1	Cover Gland	316 SS/A479
2	Valve Body	316 SS/A479
3	Cover	316 SS/A479
4	Ball Poppet	316 SS/A479
5	Spring	300 Series Stainless Steel
	Lubricant	Molybdenum Disulfide/Fluorinated-based

Wetted components listed in italics.

Ordering Information and Dimensions

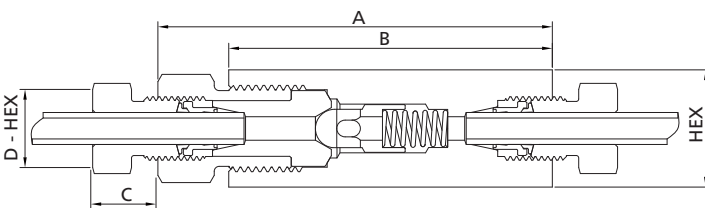

Ordering Number	Connection	Orifice in. (mm)	Cv	Dimensions, in. (mm)					Working Pressure psig (bar)
				A	B	C	D - HEX	HEX	
15COSS-DHL4	DHL4	0.188 (4.78)	0.63	3.35 (85)	2.72 (69.2)	0.52 (13.3)	0.63 (16.0)	0.81 (20.6)	15,000 (1034)
15COSS-DHL6	DHL6	0.250 (6.35)	1.70	3.72 (94.6)	3.13 (79.6)	0.53 (13.5)	0.75 (19.1)	1.00 (25.4)	15,000 (1034)
15COSS-DHL8	DHL8	0.375 (9.53)	3.40	4.41 (112.0)	3.68 (93.5)	0.60 (15.3)	0.93 (23.6)	1.38 (35.1)	15,000 (1034)

Pipe Ball Check Valves

Features

- ⦿ Working temperature range: -110°F to 400°F (-79°C to 204°C)
- ⦿ Prevents reverse flow where leak-tight shut-off is not mandatory (Not for use as relief valve)
- ⦿ An integral design of the ball and poppet to assure positive, in-line seating without "chatter".
 Poppet is designed essentially for axial flow with minimum pressure drop
- ⦿ Optional wetted materials of cover gland and ball poppet for longer life

Standard Materials of Construction

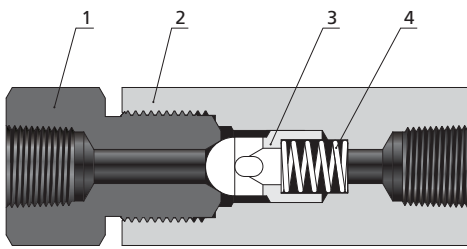

Item	Component	Material Grade/ASTM Specification
1	<i>Cover Gland</i>	<i>316 SS/A479</i>
2	<i>Valve Body</i>	<i>316 SS/A479</i>
3	<i>Ball Poppet</i>	<i>316 SS/A479</i>
4	<i>Spring</i>	<i>300 Series Stainless Steel</i>
	Lubricant	Molybdenum Disulfide/Fluorinated-based

Wetted components listed in italics.

Ordering Information and Dimensions

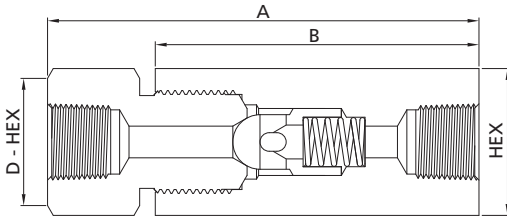

Ordering Number	Connection	Orifice in. (mm)	Cv	Dimensions, in. (mm)				Working Pressure psig (bar)
				A	B	D - HEX	HEX	
15COSS-FNS4	FNS4	0.12 (3.05)	0.28	3.30 (83.8)	2.38 (60.3)	0.94 (23.8)	0.94 (23.8)	15,000 (1034)
15COSS-FNS6	FNS6	0.22 (5.59)	0.84	3.95 (100.3)	2.88 (73.2)	1.13 (28.6)	1.13 (28.6)	15,000 (1034)
15COSS-FNS8	FNS8	0.36 (9.12)	2.30	5.07 (128.9)	3.88 (98.6)	1.38 (34.9)	1.38 (34.9)	15,000 (1034)

Medium & High Pressure Fittings and Tubing
 Quick Couplings
 Medium & High Pressure Valves
 Line Filters
 Sour Service Products
 Subsea Valves
 Tools and Installation Instructions
 Technical Information

20C Series

20,000 psig (1379 bar)

O-ring Check Valves

Features

- ⦿ Fluorocarbon FKM O-ring for operation from 0°F to 400°F (-17.8°C to 204°C), other materials of O-rings available
- ⦿ Tubing sizes available from 1/4" to 1"
- ⦿ Cracking pressure: 14 psig~26 psig (0.966 bar~1.794 bar)
- ⦿ Provides unidirectional flow and tight shut-off for liquids and gases with high reliability. When differential drops below cracking pressure, valve shuts off (Not for use as relief valve)
- ⦿ Resilient O-ring seat design for noise-free closing and zero leakage

Standard Materials of Construction

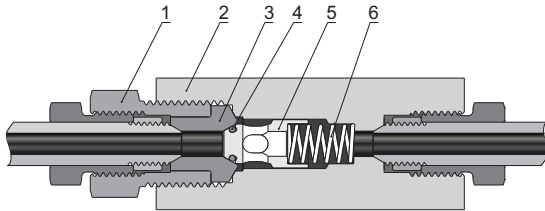

Item	Component	Material Grade/ASTM Specification
1	Cover Gland	316 SS/A479
2	Valve Body	316 SS/A479
3	Cover	316 SS/A479
4	O-ring	Fluorocarbon FKM
5	Poppet	316 SS/A479
6	Spring	300 Series Stainless Steel
	Lubricant	Molybdenum Disulfide/Fluorinated-based

Wetted components listed in italics.

Ordering Information and Dimensions

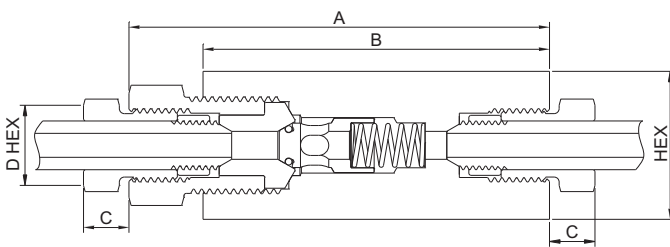

Ordering Number	Connection	Orifice in. (mm)	Cv	Dimensions, in. (mm)					Working Pressure psig (bar)
				A	B	C	D - HEX	HEX	
20CSS-2FH4	2FH4	0.125 (3.18)	0.28	2.94 (74.7)	2.50 (63.5)	0.38 (9.7)	0.50 (12.7)	0.81 (20.6)	20,000 (1379)
20CSS-2FH6	2FH6	0.218 (5.54)	0.84	3.12 (79.3)	2.62 (66.6)	0.44 (11.2)	0.62 (15.8)	1.00 (25.4)	20,000 (1379)
20CSS-2FH9	2FH9	0.359 (9.12)	2.30	4.18 (106.2)	3.50 (88.9)	0.55 (14.0)	0.94 (23.9)	1.38 (35.1)	20,000 (1379)
20CSS-2FH12	2FH12	0.516 (13.11)	4.70	5.50 (139.7)	4.75 (120.7)	0.60 (15.2)	1.19 (30.2)	1.75 (44.5)	20,000 (1379)
20CSS-2FH16	2FH16	0.688 (17.48)	7.40	6.91 (175.6)	5.75 (146.1)	0.74 (18.8)	1.38 (35.1)	2.12 (53.9)	20,000 (1379)

20CO Series

20,000 psig (1379 bar)

Ball Check Valves

Features

- ⦿ Working temperature range: -110°F to 1200°F (-79°C to 649°C)
- ⦿ Tubing sizes available from 1/4" to 1"
- ⦿ Prevents reverse flow where leak-tight shut-off is not mandatory (Not for use as relief valve)
- ⦿ An integral design of the ball and poppet to assure positive, in-line seating without "chatter".
Poppet is designed essentially for axial flow with minimum pressure drop
- ⦿ Optional wetted materials of cover gland and ball poppet for longer life

Standard Materials of Construction

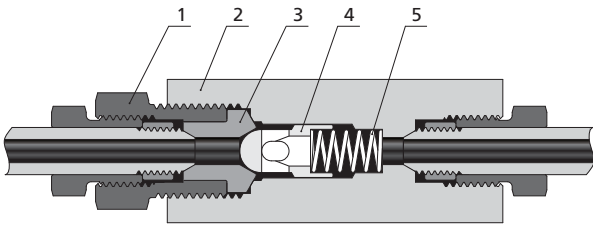

Item	Component	Material Grade/ASTM Specification
1	Cover Gland	316 SS/A479
2	Valve Body	316 SS/A479
3	Cover	316 SS/A479
4	Ball Poppet	316 SS/A479
5	Spring	300 Series Stainless Steel
	Lubricant	Molybdenum Disulfide/Fluorinated-based

Wetted components listed in italics.

Ordering Information and Dimensions

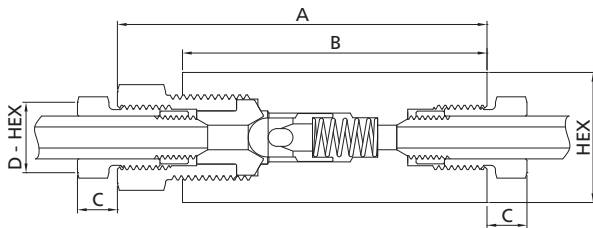

Ordering Number	Connection	Orifice in. (mm)	Cv	Dimensions, in. (mm)					Working Pressure psig (bar)
				A	B	C	D - HEX	HEX	
20COSS-2FH4	2FH4	0.125 (3.18)	0.28	2.94 (74.7)	2.50 (63.5)	0.38 (9.7)	0.50 (12.7)	0.81 (20.6)	20,000 (1379)
20COSS-2FH6	2FH6	0.218 (5.54)	0.84	3.12 (79.3)	2.62 (66.6)	0.44 (11.2)	0.62 (15.8)	1.00 (25.4)	20,000 (1379)
20COSS-2FH9	2FH9	0.359 (9.12)	2.30	4.18 (106.2)	3.50 (88.9)	0.55 (14.0)	0.94 (23.9)	1.38 (35.1)	20,000 (1379)
20COSS-2FH12	2FH12	0.516 (13.11)	4.70	5.50 (139.7)	4.75 (120.7)	0.60 (15.2)	1.19 (30.2)	1.75 (44.5)	20,000 (1379)
20COSS-2FH16	2FH16	0.688 (17.48)	7.40	6.91 (175.6)	5.75 (146.1)	0.74 (18.8)	1.38 (35.1)	2.12 (53.9)	20,000 (1379)

Medium & High Pressure Fittings and Tubing

Quick Couplings

Medium & High Pressure Valves

Line Filters

Sour Service Products

Subsea Valves

Tools and Installation Instructions

Technical Information

60C Series

60,000 psig (4137 bar)

O-ring Check Valves

Features

- Fluorocarbon FKM O-ring for operation from 0°F to 400°F (-17.8°C to 204°C), other materials of O-rings available
- Tubing sizes available from 1/4" to 9/16"
- Cracking pressure: 14 psig~26 psig (0.966 bar~1.794 bar)
- Provides unidirectional flow and tight shut-off for liquids and gases with high reliability.
When differential drops below cracking pressure, valve shuts off (Not for use as relief valve)
- Resilient O-ring seat design for noise-free closing and zero leakage

Standard Materials of Construction

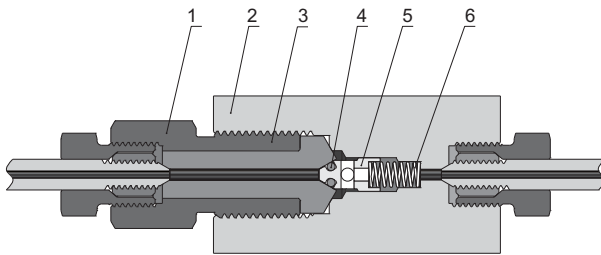

Item	Component	Material Grade/ASTM Specification
1	Cover Gland	316 SS/A479
2	Valve Body	316 SS/A479
3	Cover	316 SS/A479
4	O-ring	Fluorocarbon FKM
5	Poppet	316 SS/A479
6	Spring	300 Series Stainless Steel
	Lubricant	Molybdenum Disulfide/Fluorinated-based

Wetted components listed in italics.

Ordering Information and Dimensions

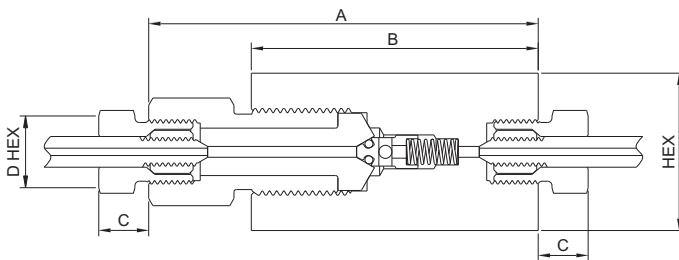

Ordering Number	Connection	Orifice in. (mm)	Cv	Dimensions, in. (mm)					Working Pressure psig (bar)
				A	B	C	D - HEX	HEX	
60CSS-6FH4	6FH4	0.094 (2.39)	0.15	3.38 (85.9)	2.50 (63.5)	0.47 (11.9)	0.63 (16.0)	1.18 (30.0)	60,000 (4137)
60CSS-6FH6	6FH6	0.125 (3.18)	0.28	3.86 (98.1)	2.80 (71.1)	0.61 (15.5)	0.81 (20.6)	1.18 (30.0)	60,000 (4137)
60CSS-6FH9	6FH9	0.187 (4.75)	0.63	4.62 (117.4)	3.38 (85.9)	0.95 (24.1)	1.12 (28.5)	1.50 (38.1)	60,000 (4137)

60CO Series

60,000 psig (4137 bar)

Ball Check Valves

Features

- ⦿ Working temperature range: -110°F to 1200°F (-79°C to 649°C)
- ⦿ Tubing sizes available from 1/4" to 9/16"
- ⦿ Prevents reverse flow where leak-tight shut-off is not mandatory (Not for use as relief valve)
- ⦿ An integral design of the ball and poppet to assure positive, in-line seating without "chatter".
 Poppet is designed essentially for axial flow with minimum pressure drop
- ⦿ Optional wetted materials of cover gland and ball poppet for longer life

Standard Materials of Construction

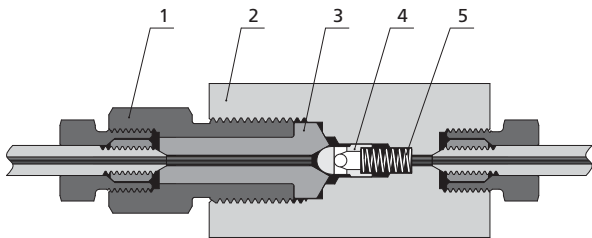

Item	Component	Material Grade/ASTM Specification
1	Cover Gland	316 SS/A479
2	Valve Body	316 SS/A479
3	Cover	316 SS/A479
4	Ball Poppet	316 SS/A479
5	Spring	300 Series Stainless Steel
	Lubricant	Molybdenum Disulfide/Fluorinated-based

Wetted components listed in italics.

Ordering Information and Dimensions

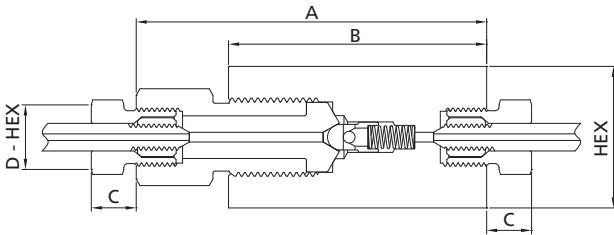

Ordering Number	Connection	Orifice in. (mm)	Cv	Dimensions, in. (mm)					Working Pressure psig (bar)
				A	B	C	D - HEX	HEX	
60COSS-6FH4	6FH4	0.094 (2.39)	0.15	3.38 (85.9)	2.50 (63.5)	0.47 (11.9)	0.63 (16.0)	1.18 (30.0)	60,000 (4137)
60COSS-6FH6	6FH6	0.125 (3.18)	0.28	3.86 (98.1)	2.80 (71.1)	0.61 (15.5)	0.81 (20.6)	1.18 (30.0)	60,000 (4137)
60COSS-6FH9	6FH9	0.187 (4.75)	0.63	4.62 (117.4)	3.38 (85.9)	0.95 (24.1)	1.12 (28.5)	1.50 (38.1)	60,000 (4137)

NOTE: All dimensions are for reference only and are subject to change. For dimensions not shown above, please contact FITOK Group or our authorized distributors.

Medium & High Pressure Fittings and Tubing

Quick Couplings

Medium & High Pressure Valves

Line Filters

Sour Service Products

Subsea Valves

Tools and Installation Instructions

Technical Information

Ordering Number Description

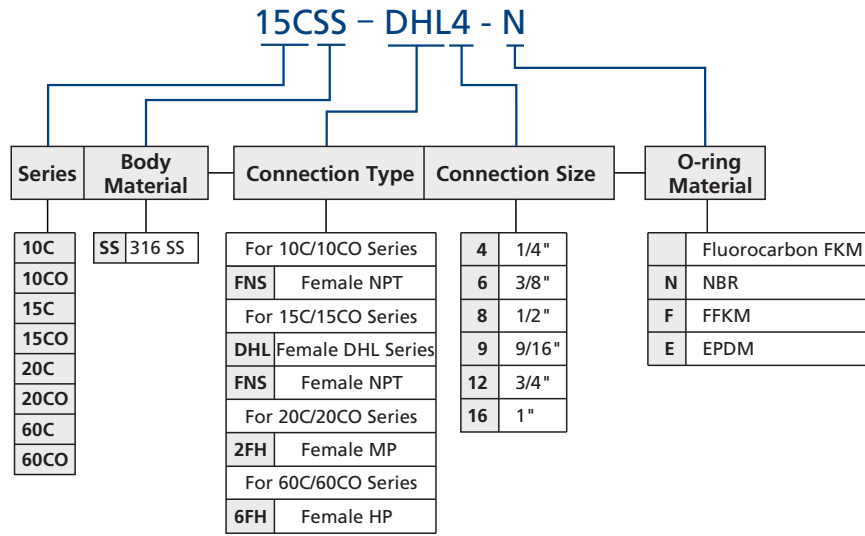

- NOTES: 1. "Ordering Number Description" is a reference to understand the combination rules of FITOK product part number. Not all combinations are available.
2. For products applied under lower temperature, please contact FITOK Group or our authorized distributors.

Code	O-ring Material	Working Temperature Range, °F (°C)
	Fluorocarbon FKM	0 to 400 (-17.8 to 204)
N	NBR	-10 to 250 (-23 to 121)
F	FFKM	-20 to 550 (-29 to 288)
E	EPDM	-50 to 300 (-45 to 148)

FIRTECH

Al. Piłsudskiego 34, 05-270 Marki, Polska

Tel.: +48 22 435-82-44, **Fax.:** +48 22 427-52-66

e-mail: FITOK@FITOKGROUP.PL

FK-IC-HV-03-EN-170505